

Pro Series

Interactive Flat Panel for Enterprise

Our complete enterprise solution is easy to use, simple to install, will work with your current system set up and is designed for over 50,000 hours of use. With low maintenance and no ongoing subscriptions, Clevertouch provides the only complete all in one solution for Enterprise.

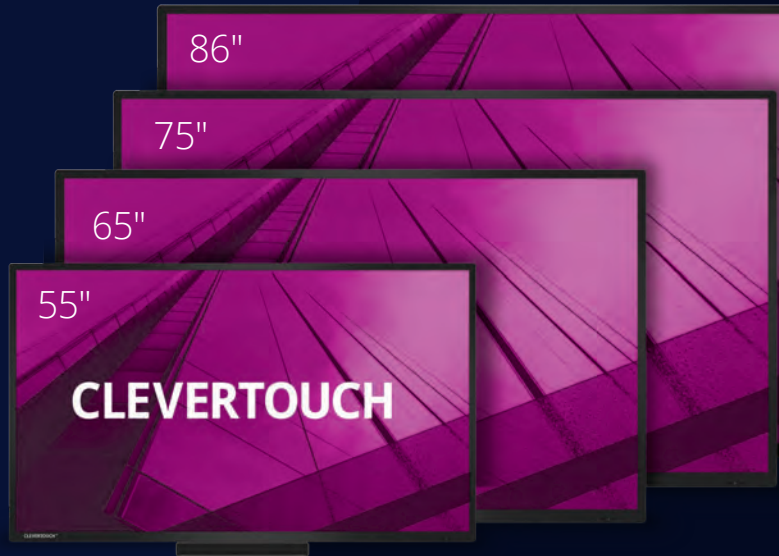

Display Technology for Collaboration and Conferencing
InAVation Awards 2018 - Winner



Manufacturer of the Year
AV Awards 2015 - Winner



Collaboration Product of the Year
Install Awards 2018 - Finalist

The award winning all-in-one solution



Flexible Solution

Our Pro Series solution is designed to be flexible and works with your existing VC solutions and software. Our open platform approach and embedded Windows OS gives you access to cloud-based applications such as Skype for Business, Slack, Zoom and Google Hangouts. Clevertouch offers long-term savings and increased return on investment.



Networking and Security

Our touchscreens are designed to integrate with your current system set up. With remote management tools, increased security and network options, and the most comprehensive warranty on the market.



Dynamic Messaging

With Clever Message send dynamic messages to your Clevertouch screens. Your IT department or office can create messages for 24/7 use with live alerts and announcements.



Natural, Fluid Writing

Our Super Glide Surface technology provides a natural and fluid writing experience with no lag, reminiscent of a pen and whiteboard. Erase with your palm. Pinch and pull to zoom. Switch between finger-touch, pen, and dual-pen instantly without needing to alter settings.



Blade PC

With an optional slot-in Windows 10 Pro Intel® Core™ i5/i7 PC, you can load your existing apps and software from your network, enabling you to collaborate securely across the globe, and access the same features as your colleagues, wherever they are based.

Open Platform Video Conferencing Solutions

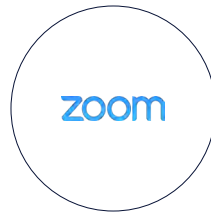
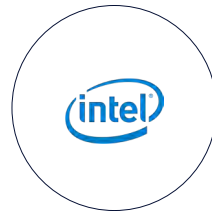
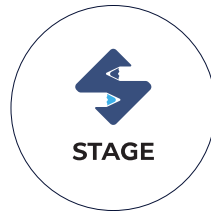

Connecting people with technology

Clever Message Application

For Cloud based company branding and messaging

Optional Blade PC

Choose from an i5 or i7 Intel Core PC with Windows 10 Pro with 4/8 GB RAM and 128/256 GB SSD, and integrated Intel® HD Graphics and Intel H110 Express Chipset.

Audio

Built-in high-end speakers

High end integrated tablet mode

Compatible with **Windows, Mac, iOS, Android** and **Chrome.**



Video conferencing

Access apps such as Zoom, Skype for Business, Slack and Stage and connect any type of camera.

Fluid and natural touch experience

With active stylus.

Superglide Surface

4mm toughened glass

Personalised account profile

Access your settings, files and Cloud accounts from your NFC key fob.

Clevertouch Features



Fully customisable



Local team with expert knowledge



Comprehensive warranty



20-point touch



Energy efficient



Compatible with existing hardware and software



4K resolution display



Smart personalised profile



Remote management



OTA (Over the air) updates



Integrated speakers



LUX user interface



No shadow



Anti-glare glass



HDMI, VGA, RS232 and USB connectivity



Optimal performance



Super glide surface

Clever Message

NEW

24/7 digital signage

Turn your Clevertouch into an interactive digital signage kiosk.

Branded power-up screen

Get your organisation's daily news when you power-up each day.

Live video streaming

Broadcast live or pre-recorded audio and video to your screens.

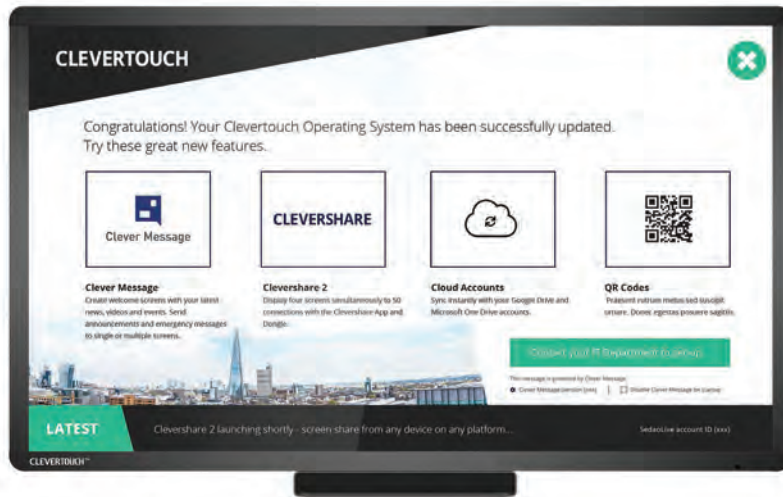

Instant messaging

Send instant or timed messages to any of your Clevertouch screens remotely.

Alerts

Send important announcements at the touch of a button.

Group your screens

Send messages to groups of Clevertouch displays simultaneously.

Clever Message Features



Add your logo



Customise with your colours



Add images and slideshows

RSS

Create RSS feeds



Live video messages



Add video and movies



Insert documents (pdf, word)



Add web pages



Touch Compatible



Add clocks with date and time



Add sound



Add text boxes



Create animations



Schedule timed messages



Choose from hundreds of themed templates



Assign zones to different staff or departments



Create groups of screens



Works over multiple locations

Pro Series Range

Capacitive Touch

Capacitive is our multi award winning premium panel for Enterprise. This true-bonded touchscreen is the most sleek, stylish 4K panel on the market. Designed with the latest technology available, capacitive gives the most natural, responsive and accurate touch experience. A true-bonded capacitive screen delivering an end-user experience unmatched by any other display.

E-CAP

The new E-CAP is a blend of two technologies, combining infrared technology, excellent for gesture control, and EMR (Electro Magnetic Resonance), best for accuracy and responsiveness. The combination of IR technology adds the benefit of gesture control using your hand or the choice of finger touch or active stylus depending on your preferred experience.

High Precision

This high precision infra-red technology. An enhancement on standard technology where our touch frames can now recognise the varied stylus to give the ability to assign different colour to different stylus's or to you stylus and finger. The ultra-precise writing experience and great gesture control is guaranteed.

Dual pen functionality - Combine dual colour styluses	✓	✓	✓
LUX business user interface	✓	✓	✓
Clevershare 2.0	✓	✓	✓
Clevercable	✓	✓	✓
Clever Message	✓	✓	✓
Pressure sensitive precise active styluses - The perfect solution for creative design	✓	✓	
Slim and lightweight	✓	✓	
Simultaneous writing gesture control and palm recognition	✓	✓	
NFC Clever account profiles		✓	✓
Super glide surface		✓	✓
True bonded capacitive technology - The ultimate interactive technology	✓		
Sleek edge-to-edge design	✓		

Remote Management (MDM)

Control multiple Clevertouch devices, wherever they are

The Clevertouch MDM system enables help desks, IT administrators and project leaders to centrally manage and support hundreds of Clevertouch devices, wherever they are. Reaching well beyond the local network boundaries, our Centralised Management System delivers a bird's-eye view of an entire device fleet, enabling administrators to give the best support possible with optimal conditions for decision-making.

Extend your support umbrella, control capabilities and manage Clevertouch screens wherever they are located and operating, both inside and beyond the organisation's network. Manage mission critical and complex IT infrastructures and simplify demanding operation and maintenance work on multiple devices.

Control hundreds of Clevertouch devices remotely

- Create groups to make sure each screen has the most suitable apps and files for where it is used, such as C-Suite, Design Studios, Maths Class, Reception Class, corporate boardroom, huddle room, etc.
- Take control of the Clevertouch screen from your desktop
- Install APKs, policies and files
- Push messages directly to the Clevertouch display, ideal for security announcements
- Anti-theft module – Lock, unlock and reset displays
- Restart or shutdown multiple screen/s remotely by a single click
- Wipe the screen
- Run diagnostics

Optionally, Clevertouch MDM can serve as the basis for managing other devices in the organisation (Android, Windows, iOS and Chrome OS) from a single console, such as desktops, laptops, tablets and smartphones.

Instant Updates (OTA)

Updates delivered instantly

The new Over-the-Air technology means that new features, bug fixes, software and hardware updates can be seamlessly delivered to every Clevertouch screen.

With just the click of a button the Clevertouch screen will search for the latest firmware update and install it, giving you instant access to the latest apps and features.

Patch fixes no longer have to be downloaded onto a USB and uploaded manually, giving IT Managers more time and less hassle.



Clevertouch PC Modules



i5 PC Module

i7 PC Module

Product Code	1541041	1541042
PC		
Type	PC Module	PC Module
Model	MT21	MT21
CPU	Intel® Core™ i5	Intel® Core™ i7
RAM	DDR4 4Gb	DDR4 8Gb
SSD	128Gb	256Gb
Graphics	Integrated Intel® HD Graphics/Independent Graphics	Integrated Intel® HD Graphics/Independent Graphics
Chipset	Intel H110 Express	Intel H110 Express
Sound Card	Integrated High Definition Audio Stereo	Integrated High Definition Audio Stereo
Networking	Integrated 10/100/1000M Adaption	Integrated 10/100/1000M Adaption
WIFI	802.11ac (2.4GHz/5GHz)	802.11ac (2.4GHz/5GHz)
Operation System	Windows 10 Pro installed	Windows 10 Pro installed
USB3.0	6	6
LAN(RJ45)	1	1
VGA Output	1	1
Earphone Output	1	1
Microphone Input	1	1
Display Port	1	1
HDMI Output	1	1
Power		
Power Supply Mode	Internal Power Supply Module	Internal Power Supply Module
Power Requirements	100-240V~ 50/60Hz	100-240V~ 50/60Hz
Max Power	95W	95W
Standby Power	1.35W	1.35W
Physical Specs		
Cover Material	SECC	SECC
Dimension L x W x H	246.2 x 265.4 x 32.2mm	246.2 x 265.4 x 32.2mm
Net Weight	1.9kg	1.9kg
Environmental Conditions		
Operation Temperature	0°C – 45°C	0°C – 45°C
Operation Humidity	10% – 90%	10% – 90%
Storage Temperature	-20°C – 60°C	-20°C – 60°C
Storage Humidity	10% – 90%	10% – 90%
ESD		
Contact Discharge	±4KV passed level A test(CB)/ ±6KV passed level B test(CB)	±4KV passed level A test(CB)/ ±6KV passed level B test(CB)
Non-contact Discharge	10% ±8KV passed level A test(CB)/ ±12KV passed level B test(CB)	10% ±8KV passed level A test(CB)/ ±12KV passed level B test(CB)

	65" Pro Series E-CAP 15465PROECAP	75" Pro Series E-CAP 15475PROECAP	86" Pro Series E-CAP 15486PROECAP	65" Capacitive Touch 15465CAP
Product Code	15465PROECAP	15475PROECAP	15486PROECAP	15465CAP
Display				
Screen Type	LED	LED	LED	LED
Aspect Ratio	16:09	16:09	16:09	16:09
Resolution	4K Ultra HD	4K Ultra HD	4K Ultra HD	4K Ultra HD
Backlight	E-LED	E-LED	E-LED	E-LED
Brightness (cd/m ²)	350	350	350	350
Response Time	8ms	8ms	8ms	8ms
Audio	2 x 12W	2 x 12W	2 x 12W	Mid 1x12W; Bass 2x12W
Android	✓	✓	✓	✓
Glass	Anti Glare	Anti Glare	Anti Glare	Anti Glare
Super Glide Surface	✓	✓	✓	✓
Contrast Ratio	4000:1	4000:1	4000:1	4000:1
Interactive System				
Touch Points	20	20	20	20
Sensor Type	IR & EMR	IR & EMR	IR & EMR	P-Cap & EMR
Minimum Object Size (mm)	IR 6 & EMR 2	IR 6 & EMR 2	IR 6 & EMR 2	Touch <2 & EMR 0.5
Response Time (Touch)	< 15ms	< 15ms	< 15ms	N/A
Connectivity				
USB 2.0 / 3.0 / Touch	2 / 2 / 1	2 / 2 / 1	2 / 2 / 1	8 / 2 / 1
HDMI 1.4 In / 2.0 in	0 / 2	0 / 2	0 / 2	1 / 1
DisplayPort in	0	0	0	0
VGA Input	1	1	1	1
HDMI Out	1	1	1	1
CVBS (requires a 3.5mm to 3 x phono socket, not included)	✓	✓	✓	✓
PC-Audio	✓	✓	✓	✓
VGA Output	X	X	X	X
LAN (RJ45)	✓	✓	✓	✓
RS232	✓	✓	✓	✓
Android Module Slot	✓	✓	✓	✓
PC Module Slot	✓	✓	✓	✓
Power				
Power	300W	300W	400W	250W
Power (in standby)	<0.5W	<0.5W	<0.5W	<0.5W
EU Energy Rating - Efficiency Class	B	A	A	TBD
Physical Specifications				
Dimensions W x H x D (mm / ")	1508 x 902 x 75 / 59 3/8 x 35 33/64 x 2 61/64	1753 x 1022 x 75 / 69 1/64 x 40 15/64 x 2 61/64	1978 x 1166 x 75 / 77 7/8 x 45 29/32 x 2 61/64	1505 x 882 x 62 / 59 1/4 x 34 23/32 x 2 7/16
Weight	45kg / 99lb 3oz	70kg / 154lb 5oz	83.85kg / 184lb 14oz	49kg / 165lb 6oz
VESA (mm / ")	600 x 200 / 23 5/8 x 15 3/4	600 x 200 / 23 5/8 x 15 3/4	600 x 200 / 23 5/8 x 15 3/4	600 x 230 / 23 5/8 x 9 1/16
Android Capabilities				
Remote Management (MDM)	5 Year	5 Year	5 Year	5 Year
Instant updates (OTA)	✓	✓	✓	✓
System Version	Android 6.0.1 Marshmallow			
CPU	RK3399 Dual-core ARM Cortex A72 and Quad-core ARM Cortex-A53			
Android Resolution	1080p	1080p	1080p	1080p
GPU	Mali-T860	Mali-T860	Mali-T860	Mali-T860
RAM	4G	4G	4G	4G
ROM	16GB	16GB	16GB	16GB
Wi-Fi Enabled	✓	✓	✓	✓
Apps and Android Features				
Whiteboard App	X	X	X	X
Email Out	✓	✓	✓	✓
Cleverstore	X	X	X	X
Lynx App	X	X	X	X
Lynx Pro	✓	✓	✓	✓
Clever Message – 24/7 Dynamic Messaging Service NEW	✓	✓	✓	✓
Dual Pen Mode NEW	✓	✓	✓	✓
Clevershare 2 App NEW	✓	✓	✓	✓
Software				
Lynx	X	X	X	X
Snowflake	X	X	X	X
DisplayNote	X	X	X	X
Montage	✓	✓	✓	✓
LynxPro Meeting	✓	✓	✓	✓
Stage	✓	✓	✓	✓
Accessories				
i5 PC Module included (1541041)	X	X	X	✓
USB Camera Ability	✓	✓	✓	✓
Writing Pen or Stylus	2 (EMR Active Pens)	2 (EMR Active Pens)	2 (EMR Active Pens)	2 (EMR Active Pens)
VGA, Audio Cables	✓	✓	✓	✓
HDMI, USB Cables	✓	✓	✓	✓
Clevershare 1541052 x2	✓	✓	✓	✓
Clevercable	✓	✓	✓	✓
Smart Personalised Profile Account (Pen Tray & NFC 1541053) NEW	✓	✓	✓	X

	55" Pro Series HP	65" Pro Series HP	75" Pro Series HP	86" Pro Series HP
Product Code	15455PROHP	15465PROHP	15475PROHP	15486PROHP
Display				
Screen Type	LED	LED	LED	LED
Aspect Ratio	16:09	16:09	16:09	16:09
Resolution	4K Ultra HD	4K Ultra HD	Full HD	4K Ultra HD
Backlight	D-LED	D-LED	D-LED	D-LED
Brightness (cd/m ²)	350	350	350	350
Response Time	8ms	8ms	8ms	8ms
Audio	2 x 12W	2 x 12W	2 x 12W	2 x 12W
Android	✓	✓	✓	✓
Glass	Anti Glare	Anti Glare	Anti Glare	Anti Glare
Super Glide Surface	✓	✓	✓	✓
Contrast Ratio	1200:1	1200:1	1200:1	1200:1
Interactive System				
Touch Points	20	20	20	20
Sensor Type	High Precision IR	High Precision IR	High Precision IR	High Precision IR
Minimum Object Size (mm)	3	3	3	3
Response Time (Touch)	< 15ms	< 15ms	< 15ms	< 15ms
Connectivity				
USB 2.0 / 3.0 / Touch	4 / 2 / 1	4 / 2 / 1	4 / 2 / 1	4 / 2 / 1
HDMI 1.4 In / 2.0 in	0 / 2	0 / 2	0 / 2	0 / 2
DisplayPort in	0	0	0	0
VGA Input	1	1	1	1
HDMI Out	1	1	1	1
CVBS (requires a 3.5mm to 3 x phono socket, not included)	✓	✓	✓	✓
PC-Audio	✓	✓	✓	✓
VGA Output	X	X	X	X
LAN (RJ45)	✓	✓	✓	✓
RS232	✓	✓	✓	✓
Android Module Slot	✓	✓	✓	✓
PC Module Slot	✓	✓	✓	✓
Power				
Power	250W	300W	450W	500W
Power (in standby)	<0.5W	<0.5W	<0.5W	<0.5W
EU Energy Rating - Efficiency Class	B	A+	C	B
Physical Specifications				
Dimensions W x H x D (mm / ")	1318 x 789 x 103 / 51 5/64 x 31 1/16 x 4 1/16	1537 x 913 x 99 / 60 33/64 x 35 15/16 x 3 57/64	1779 x 1032 x 100 / 70 3/64 x 40 5/8 x 3 15/16	2004 x 1176 x 99.6 / 78.9 57/64 x 46 19/64 x 3 59/64
Weight	36.5kg / 80lb 7.4oz	49kg / 108lb	57.8kg / 127lb 6.8oz	73.7kg / 162lb 8oz
VESA (mm / ")	400 x 400 / 15 3/4 x 15 3/4	600 x 400 / 23 5/8 x 15 3/4	800 x 400 / 31 1/2 x 15 3/4	800 x 600 / 31 1/2 x 23 5/8
Android Capabilities				
Remote Management (MDM)	5 Year	5 Year	5 Year	5 Year
Instant updates (OTA)	✓	✓	✓	✓
System Version	Android 6.0.1 Marshmallow			
CPU	RK3399 Dual-core ARM Cortex A72 and Quad-core ARM Cortex- A53			
Android Resolution	1080p	1080p	1080p	1080p
GPU	Mali-T860	Mali-T860	Mali-T860	Mali-T860
RAM	4G	4G	4G	4G
ROM	16GB	16GB	16GB	16GB
Wi-Fi Enabled	✓	✓	✓	✓
Apps and Android Features				
Whiteboard App	X	X	X	X
Email Out	✓	✓	✓	✓
Cleverstore	X	X	X	X
Lynx App	X	X	X	X
Lynx Pro	✓	✓	✓	✓
Clever Message – 24/7 Dynamic Messaging Service NEW	✓	✓	✓	✓
Dual Pen Mode NEW	✓	✓	✓	✓
Clevershare 2 App NEW	✓	✓	✓	✓
Software				
Lynx	X	X	X	X
Snowflake	X	X	X	X
DisplayNote	X	X	X	X
Montage	✓	✓	✓	✓
LynxPro Meeting	✓	✓	✓	✓
Stage	✓	✓	✓	✓
Accessories				
i5 PC Module included (1541041)	X	X	X	X
USB Camera Ability	✓	✓	✓	✓
Writing Pen or Stylus	2	2	2	2
VGA, Audio Cables	✓	✓	✓	✓
HDMI, USB Cables	✓	✓	✓	✓
Clevershare 1541052 x2	✓	✓	✓	✓
Clevercable	✓	✓	✓	✓
Smart Personalised Profile Account (Pen Tray & NFC 1541053) NEW	X	X	X	X

65" Pro Series | E-CAP

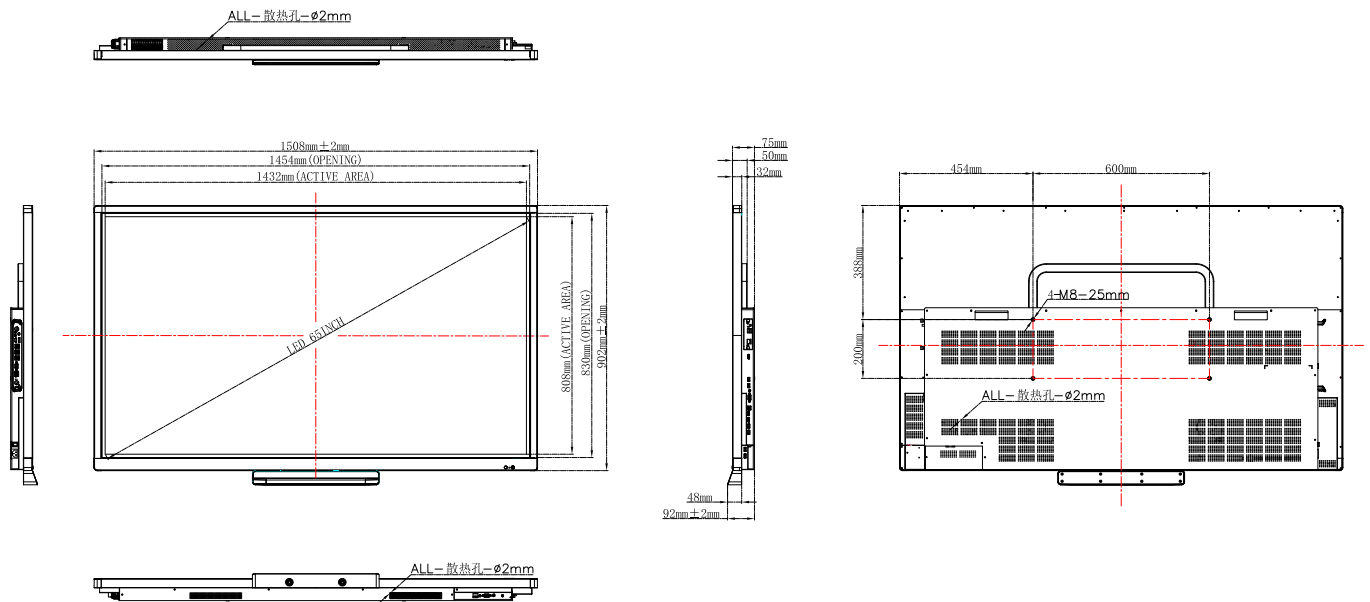

75" Pro Series | E-CAP

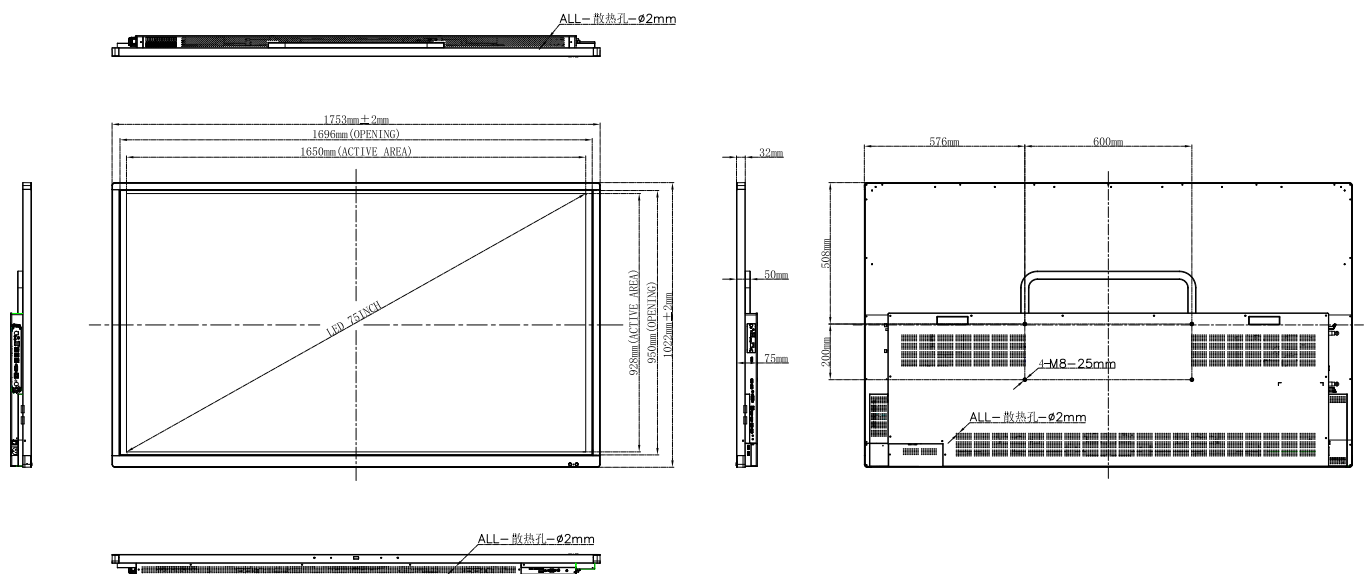

86" Pro Series | E-CAP

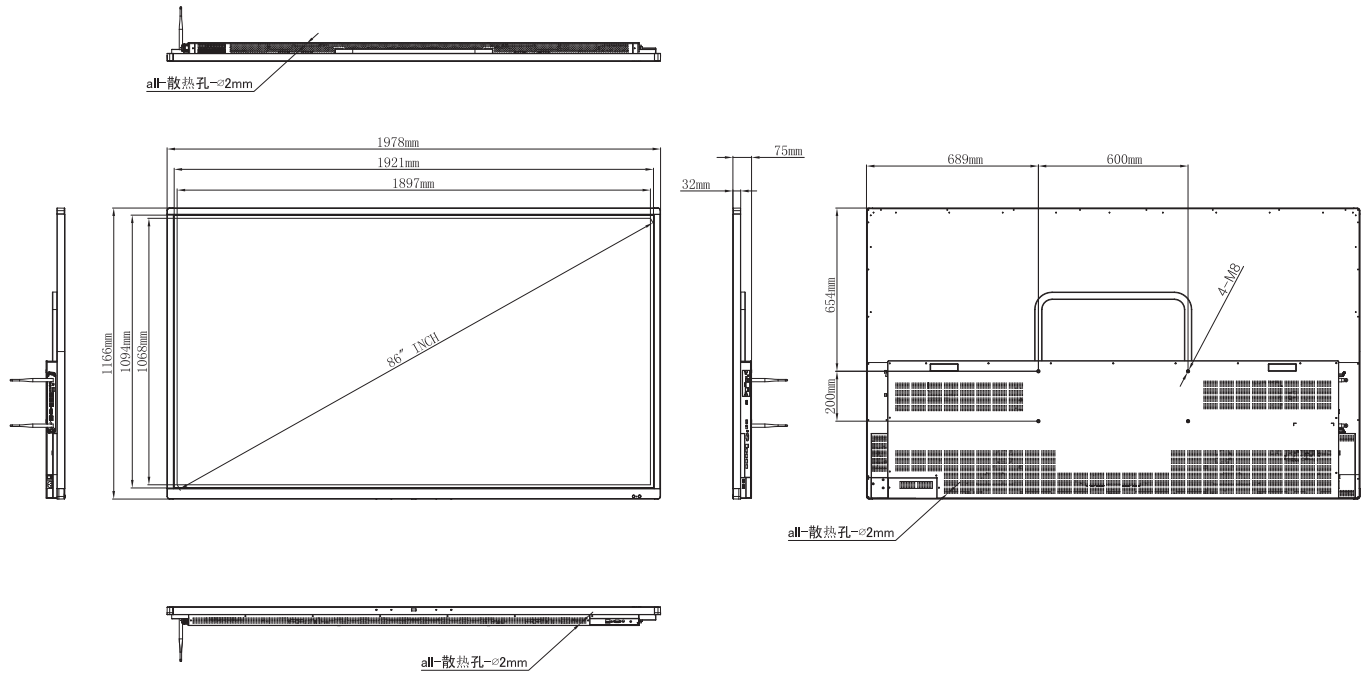

65" Capacitive Touch

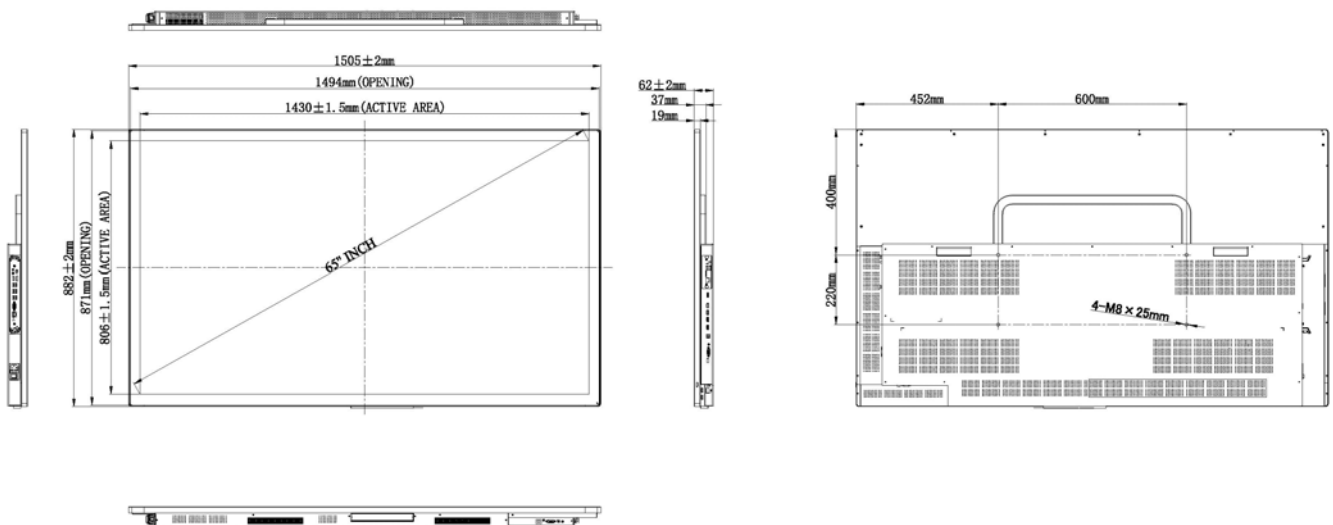

55" Pro Series | High Precision

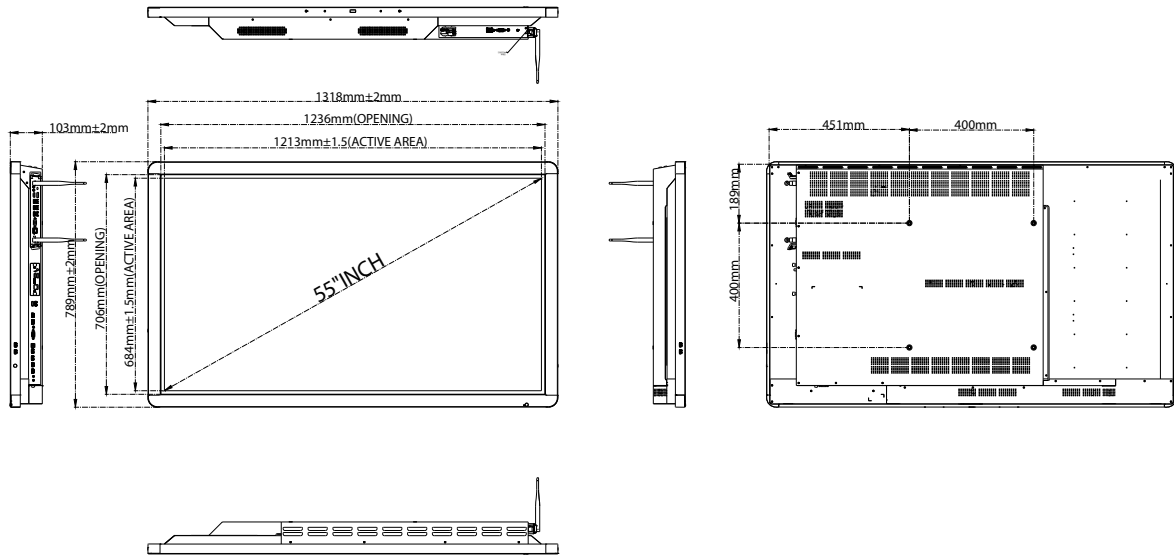

65" Pro Series | High Precision

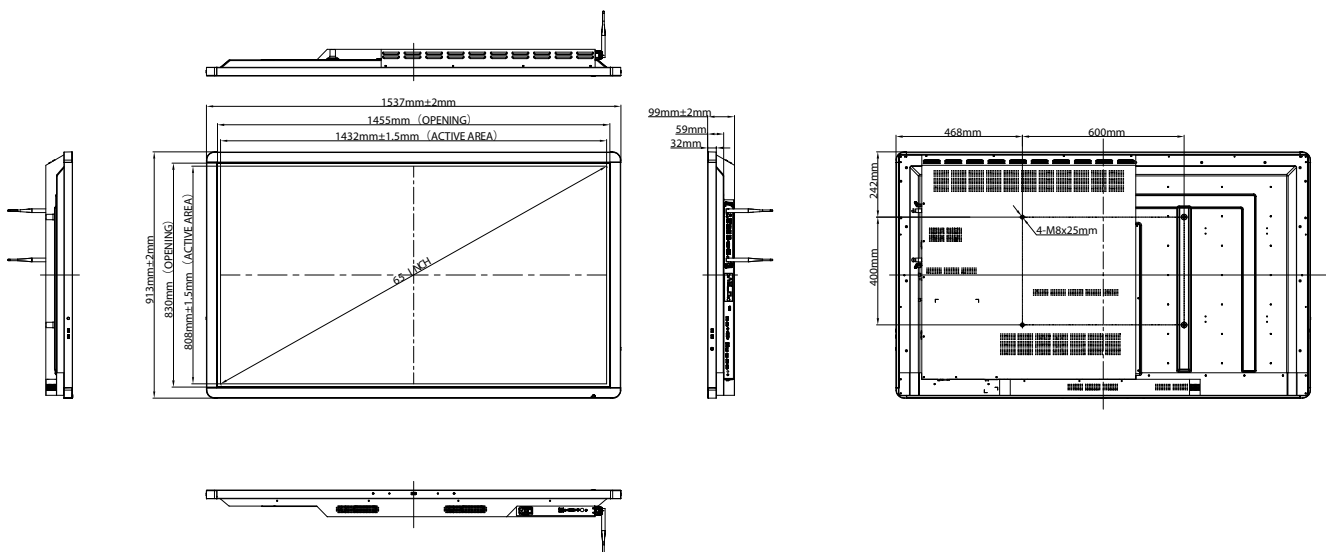

75" Pro Series | High Precision

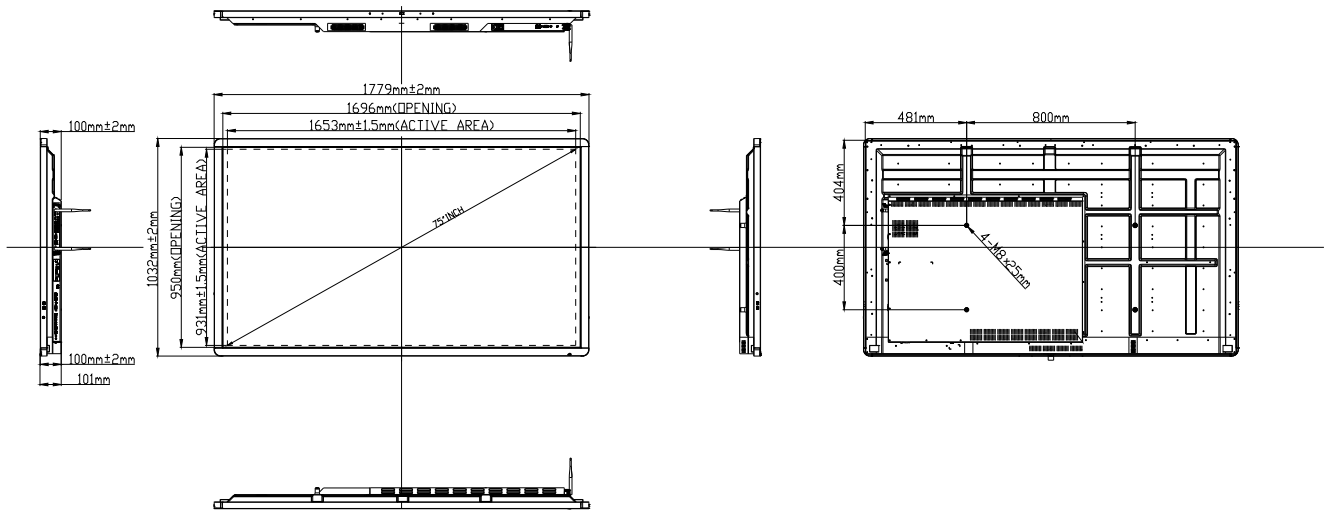

86" Pro Series | High Precision

